

## 10A 200V Fast recovery diode

### 1 Description

10A, 200V Ultrafast Diodes They have a low forward voltage drop and are of planar, silicon nitride passivated, ion-implanted, epitaxial construction. These devices are intended for use as energy steering/clamping diodes and rectifiers in a variety of switching power supplies and other power switching applications. Their low stored charge and ultrafast recovery with soft recovery characteristics minimizes ringing and electrical noise in many power switching circuits, thus reducing power loss in the switching transistor

### 2 Features

- Low power loss,
- high efficiency Low forward voltage,
- high current capability High surge capacity
- Super fast recovery times
- high voltage

### 3 Applications

- Switching Power Supply
- Power Switching Circuits
- Inverter power supply

### 4 Electrical Characteristics

#### 4.1 Absolute Maximum Ratings (Tc=25°C, unless otherwise noted)

PARAMETER	SYMBOL	VALUE	UNIT
Peak Repetitive Reverse Voltage	$V_{RRM}$	200	V
Working Peak Reverse Voltage	$V_{RWM}$	200	V
DC Blocking Voltage	$V_R$	200	V
Average Rectified Forward Current(single)	$I_{F(AV)}$	10	A
Average Rectified Forward Current(double)		20	A
Repetitive Peak Surge Current(single)	$I_{FRM}$	15	A
Nonrepetitive Peak Surge Current(single)	$I_{FSM}$	150	A
Avalanche Energy(single)	$E_{AS}$	20	mJ
Operating Junction Temperature Range	$T_j$	-55~150	°C
Storage Temperature Range	$T_{stg}$	-55~150	°C

#### 4.2 Thermal Characteristics

PARAMETER	SYMBOL	VALUE	UNIT
Thermal Resistance, Junction to Case-sink	$R_{thJC}$	0.7	°C/W

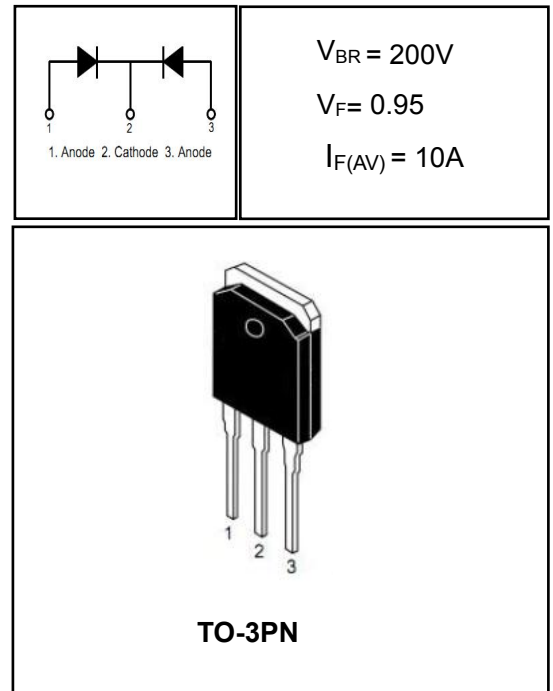

**4.3 Electrical Characteristics** (Tc=25°C, unless otherwise noted)

PARAMETER	SYMBOL	TEST CONDITION	MIN	TYP	MAX	UNIT
Maximum Instantaneous Forward Voltage	V <sub>F</sub>	I <sub>F</sub> = 10A	-	0.84	0.95	V
		I <sub>F</sub> = 10A, T <sub>C</sub> = 150°C	-	-	0.8	V
		I <sub>F</sub> = 20A	-	0.89	1	V
Maximum Instantaneous Reverse	I <sub>R</sub>	V <sub>R</sub> = 200V	-	-	5	uA
		V <sub>R</sub> = 200V, T <sub>C</sub> = 150°C	-	-	1	mA
Maximum Reverse Recovery Time	t <sub>rr</sub>	V <sub>R</sub> =30V I <sub>F</sub> =1A -di/dt=50A/us	-	20	35	ns
Total capacitance	C <sub>tot</sub>	V <sub>R</sub> =0V f=1MHz	-	305	-	pF
DC Blocking Voltage	V <sub>BR</sub>	I <sub>R</sub> =100uA	210	240	-	V

DEFINITIONS

V<sub>F</sub> = Instantaneous forward voltage (pw = 300μs, D = 2%).

I<sub>R</sub> = Instantaneous reverse current.

RθJC = Thermal resistance junction to case.

pw = pulse width.

D = duty cycle.

**5 Typical characteristics diagrams**

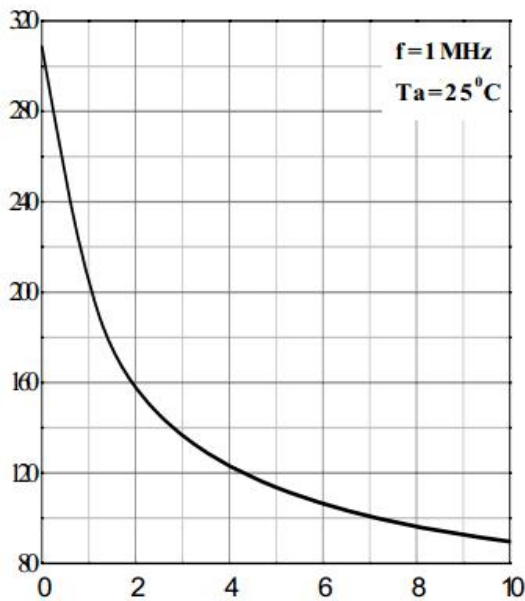

FIGURE 1. Total capacitance vs Voltage

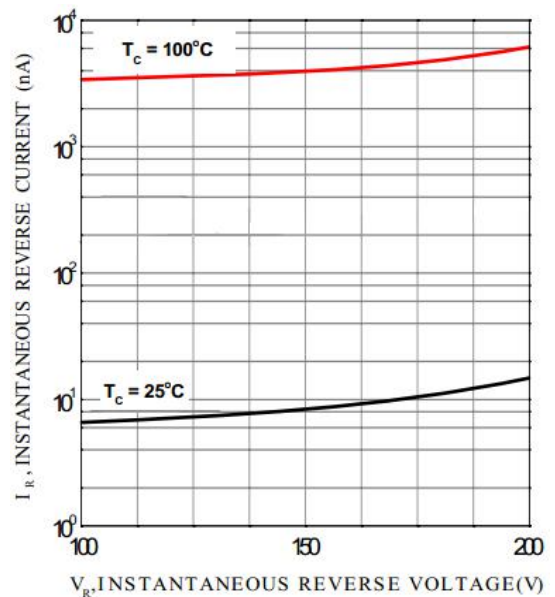

FIGURE 2. REVERSE CURRENT vs REVERSE VOLTAGE

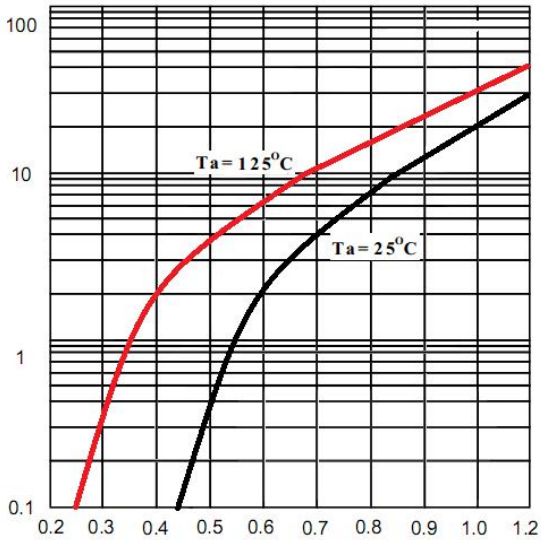

FIGURE 3. FORWARD CURRENT vs FORWARD VOLTAGE

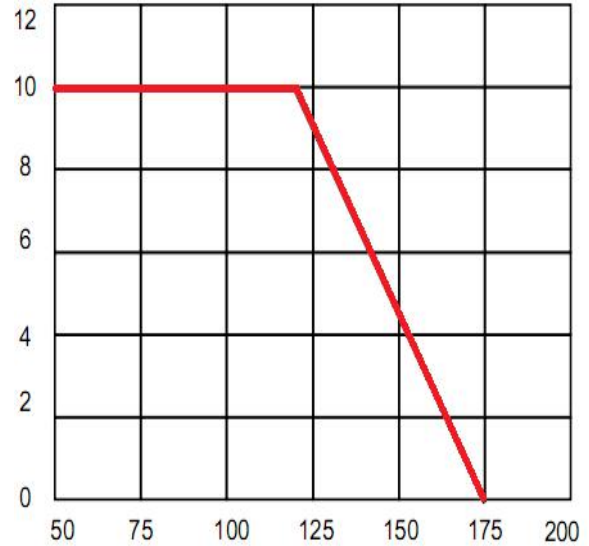

FIGURE 4. CURRENT DERATING CURVE

## 6 Typical Test Circuit and Waveform

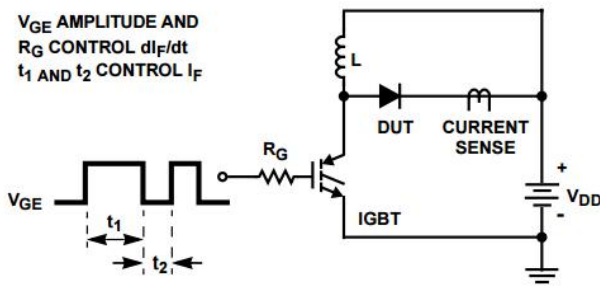

FIGURE 5. trr TEST CIRCUIT

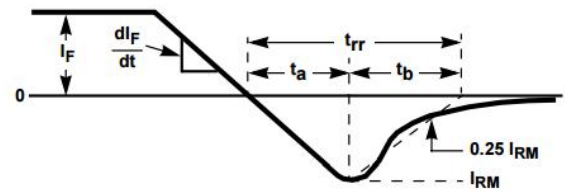

FIGURE 6. trr WAVEFORMS AND DEFINITIONS

$I = 1A$   
 $L = 40mH$   
 $R < 0.1\Omega$   
 $E_{AVL} = 1/2LI^2 [V_{R(AVL)}/(V_{R(AVL)} - V_{DD})]$   
 $Q_1 = IGBT (BV_{CES} > DUT V_{R(AVL)})$

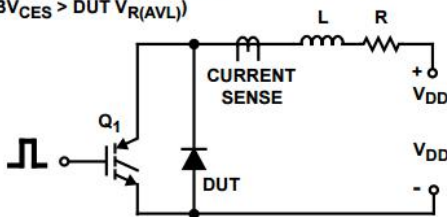

FIGURE 7. AVALANCHE ENERGY TEST CIRCUIT FIGURE

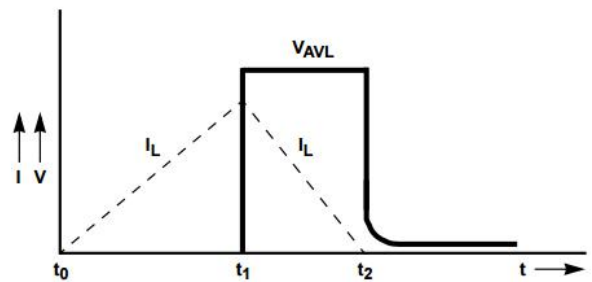
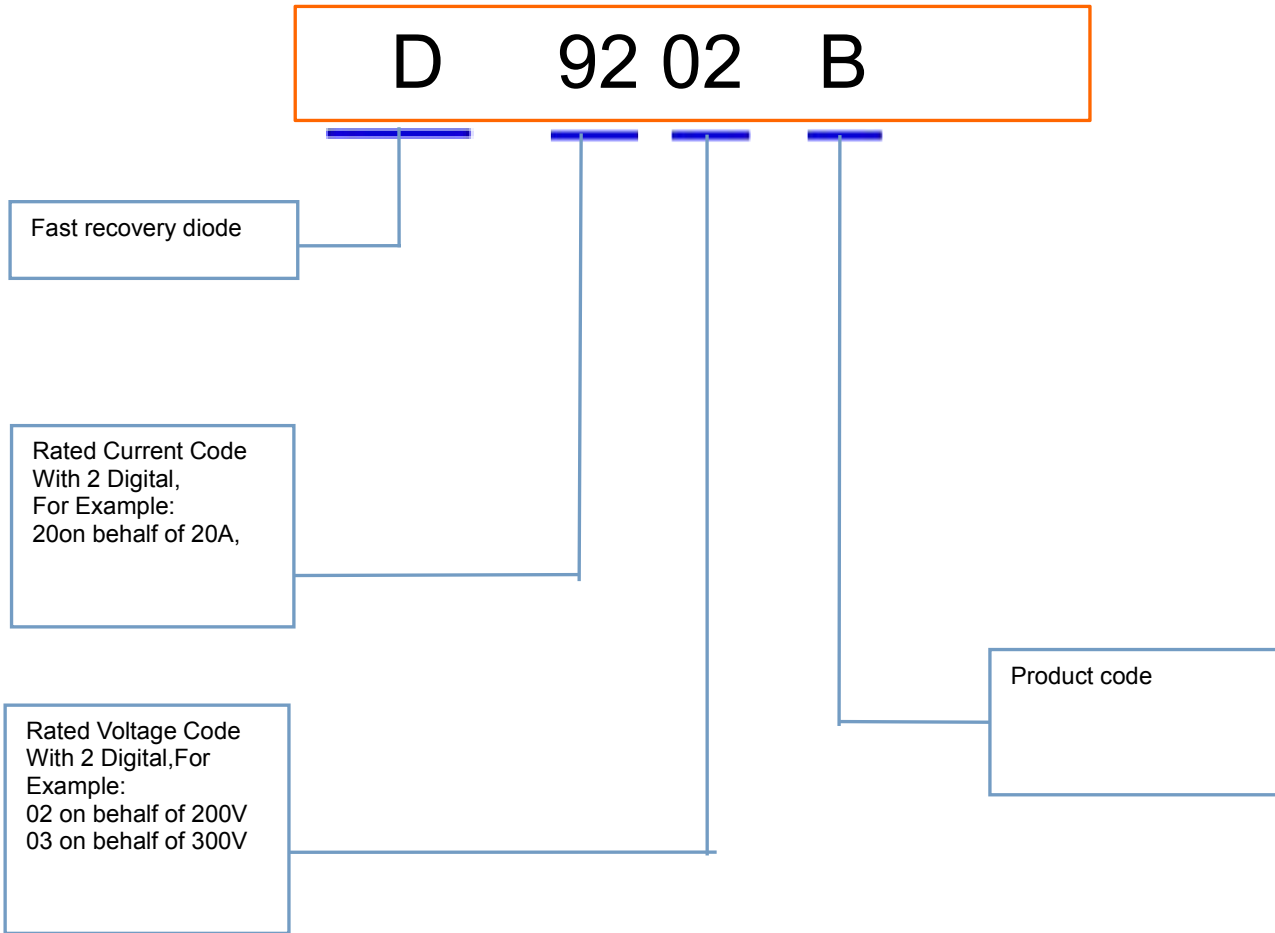

FIGURE 8. AVALANCHE CURRENT AND VOLTAGE WAVEFORMS

## 7 Product Names Rules



## 8 Product Specifications and Packaging Models

Product Model	Package Type	Mark Name	RoHS	Package	Quantity
D92-02B	TO-3PN	D92-02B	Pb-free	Tube	300/box

### 9 Dimensions

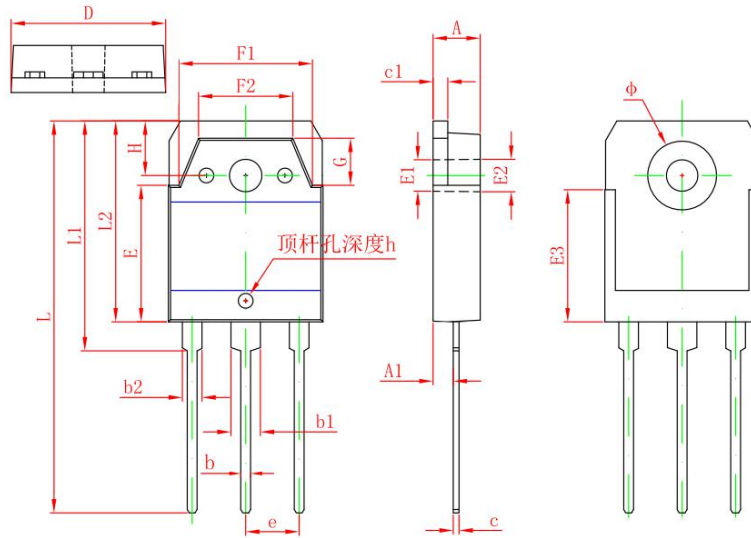

Symbol	Dimensions In Millimeters		Dimensions In Inches	
	Min	Max	Min	Max
A	4.600	5.000	0.181	0.197
A1	2.200	2.600	0.087	0.102
b	0.800	1.200	0.031	0.047
b1	2.800	3.200	0.110	0.126
b2	1.800	2.200	0.071	0.087
c	0.500	0.700	0.020	0.028
c1	1.450	1.650	0.057	0.065
D	15.450	15.850	0.608	0.624
E	13.700	14.100	0.539	0.555
E1	3.200 REF		0.126 REF	
E2	3.300 REF		0.130 REF	
E3	13.450 REF		0.530 REF	
F1	13.400	13.800	0.528	0.543
F2	9.400	9.800	0.370	0.386
L	39.900	40.300	1.571	1.587
L1	23.200	23.600	0.913	0.929
L2	20.300	20.600	0.799	0.811
Φ	6.900	7.100	0.272	0.280
G	5.150	5.550	0.203	0.219
e	5.450 TYP		0.215 TYP	
H	5.000 REF		0.197 REF	
h	0.000	0.300	0.000	0.012

### 10 Attentions

- ROUM Semiconductor Technology CO.,LTD. reserves the right to change the specification without prior notice! The customer should obtain the latest version of the information before making the order and verify that the information is complete and up to date.
- It is the responsibility of the purchaser for any failure or failure of any semiconductor product under certain conditions. It is the responsibility of the purchaser to comply with safety standards and to take safety measures in the system design and machine manufacturing of Roma products in order to avoid potential risk of failure. Injury or property damage.
- Product promotion is endless, our company will be dedicated to provide customers with better products.

### 11 Appendix

Revision history:

Date	REV.	Description	Page
2017.09.1	1.0	Original	